

NP-AFM

The NP-AFM is a complete nanoprofiler tool including everything required for scanning samples: microscope stage, electronic box, control computer, probes, manuals, and a video microscope.

Samples as large as 200 x 200 x 20 mm are profiled by the NP-AFM system, and several stage options are available for many types of samples.

- ▶ Nanoprofiler AFM for:
 - Technical samples
 - Wafers and discs
- ▶ Three sample stage options to accommodate substrates up to 200 x 200 x 20 mm
- ▶ Integrated high resolution video microscope
- ▶ Linearized XY piezoelectric scanner
- ▶ Accommodates standard-sized AFM probes
- ▶ Includes vibrating and non-vibrating topography modes, plus lateral force and phase mode imaging
- ▶ Utilizes a direct drive motorized probe approach
- ▶ Captures images with intuitive LabVIEW™-based software

Using the industry-standard light lever force sensor, all of the standard scanning modes are included with the system. Vibrating mode is used for high resolution and soft samples, while non-vibrating mode can be used for routine scanning. Also included with the system are phase and lateral force modes.

Control software, written in LabVIEW, is simple and intuitive to use. Differing windows walk users through the process: a pre-scan window helps align the AFM probe, a scanning window aids in acquiring images, a force position window is used for measuring F/D curves, and finally, a system window assists in altering system parameters.

Use the NP-AFM for routine scanning of technical samples such as wafers and disks or for nanotechnology research.



NP-AFM CAPABILITIES

Polished and machined surfaces of semiconductors, glass, and metals are readily scanned with the NP-AFM. Due to its flexible stage design, fixtures can be created for holding almost any sample shape. Additionally, the stage can hold many smaller samples that may then be imaged in a specific order.

Once measured, the AFM images can be analyzed and standard surface texture parameters, such as Ra, are readily calculated.

▶ Measure Surface Texture and Roughness

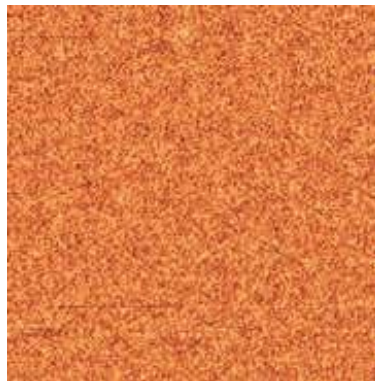

Parameters	
Average value:	-0.000
Minimum:	-2.097
Maximum:	1.826
Median:	0.001
Ra (Sa):	0.364
Rms (Sq):	0.456
Skew:	-0.0198
Kurtosis:	-0.000568

10 X 10 μ vibrating mode scan of a silicon surface showing a surface roughness (Ra) of 0.364 nm.

▶ Measure Surface Texture and Roughness

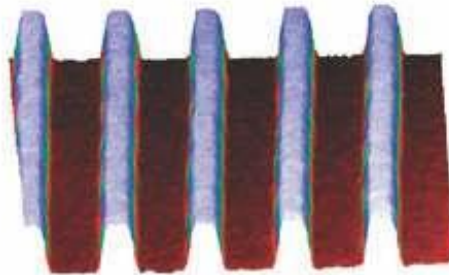

Three dimensional view: 2 x 2 μ scan, diffraction grating.

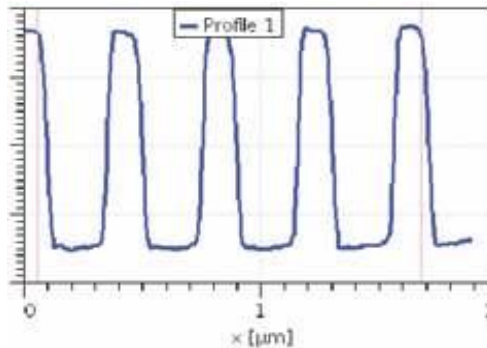

Line profile of diffraction grating showing pitch of the grating.

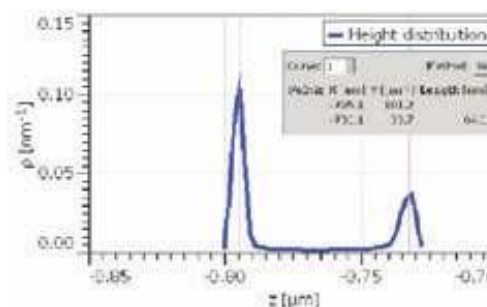

Histogram analysis showing height of features in the diffraction grating.

Atomic force microscopes are capable of accurately measuring the dimensions of semiconductor and other micro-fabricated devices. Because the NP-AFM has been designed to accommodate commercially available AFM probes, users can easily install specialized probes for metrology measurements.

Step heights and pitch are among the dimensional measurements readily made with the NP-AFM. Either Gwyddion open source software, provided with the NP-AFM system, or alternate commercial analysis packages, can be used to analyze the data.

NP-AFM CAPABILITIES

CONTINUED...

One of the most powerful capabilities of the NP-AFM is visualizing surface structure. Although not easily quantified, the surface texture of the lines on the 2 μ grating (at right) is readily visualized.

Features ranging in size from a few nm to a few μ are easily visualized by the NP-AFM.

► Visualization

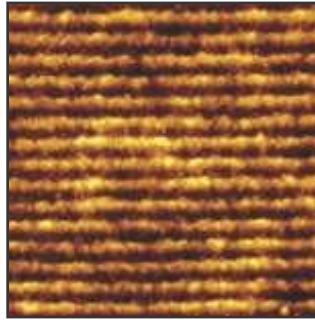

2 x 2 μ image of a grating.



40 x 40 μ image of a gear fabricated with MEMS.

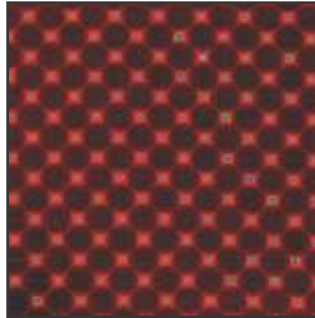

20 x 20 μ image of a silicon test pattern

► Modes

In addition to excelling in surface structure measurement, the NP-AFM is ideal for modes measurements.

For example, the images presented here are of a polymer sample. The left image is the topography image and the image at the right is the phase image, which measures the relative hardness of the polymer sample.

Standard modes include lateral force, force-distance, and phase. Optional modes include conductive AFM.

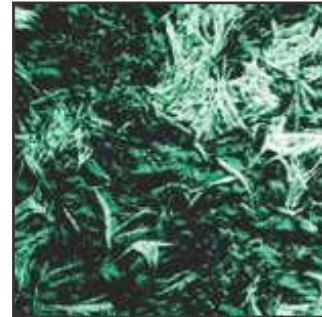
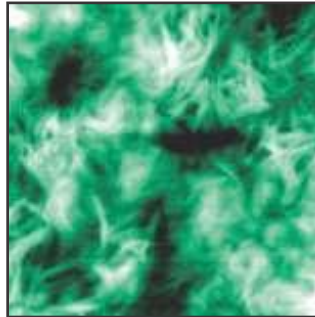

20 x 20 μ image of a polymer sample. At the left is a topography image and at the right is a phase mode image

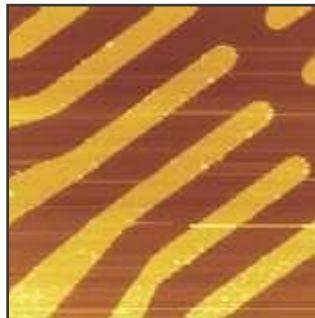

10 x 10 μ image of silicon sample with gold pattern. At the left is a topography image and at the right is a conductive AFM image. Two of the "fingers" on the test pattern are grounded and show contrast in the conductive AFM image.

NP-AFM STAGE

The NP-AFM stage has excellent thermal and mechanical stability required for high resolution AFM profiling. Additionally, its open design facilitates user modification.

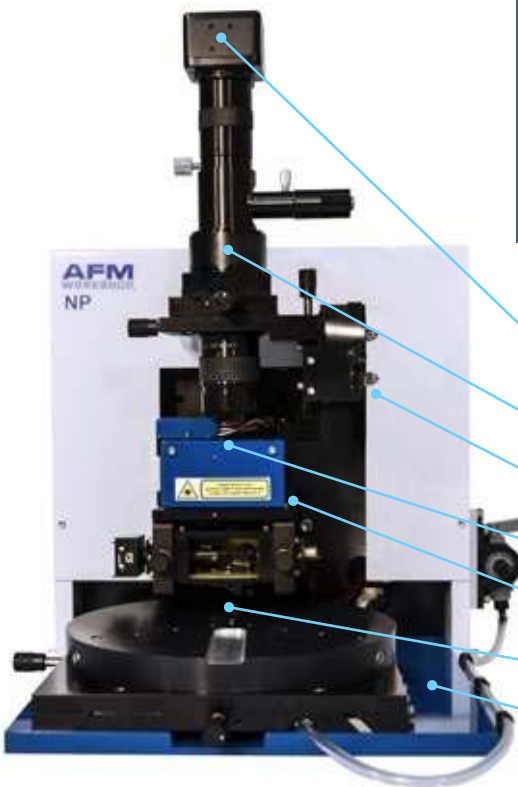

- ▶ **High Resolution Z Stage**
The direct drive's Z stage controls motion down to 330 nm, assuring optimal tip approach. Software controls for the Z stage rapidly move the light lever up and down and regulate the automated probe approach.
- ▶ **Sample Stage**
The NP-AFM has multiple stage options, including a 2 x 3" manual stage with a resolution of 2 μ, and a sample stage for wafers and discs.
- ▶ **Light Lever Force Sensor**
An industry-standard light lever force sensor is utilized in the NPAFM. Most commercially available AFM probes are accommodated in the probe holder. The light lever force sensor can make measurements in standard modes, including vibrating, non-vibrating, lateral force, and phase mode.
- ▶ **Video Microscope**
The high resolution video microscope has a zoom tube which allows a field of view between 2 x 2 mm and .3 x .3 mm. The video microscope is essential for aligning the light lever laser, locating features for scanning, and facilitating tip approach.
- ▶ **XY Piezo Scanner**
For XY scanning, linearized piezo electric ceramics utilize real-time feedback control to assure accurate measurements. The multiple modified tripod design (MMTD) of the XY scanner provides scans with minimal background bow.
- ▶ **Probe holder**
A modular probe holder is used in the light lever force sensor and held in place with a spring clip. Probes can be replaced in less than two minutes with the NP-AFM's probe exchange tool.

- High resolution 3MP CCD color camera video microscope
- XYZ video microscope positioning
- High performance linear Z translator
- Linearized XY piezo scanner
- Light lever force sensor
- Sample stage - vacuum stage shown here
- Small footprint, high stability stage structure

NP-AFM-4012 STAGE

The NP-AFM-4012 Stage is designed to accommodate many sample shapes and sizes.

The stage comes with a holder for 6 standard AFM magnetic disks. Custom sized sample holders may be readily designed and added to the stage.

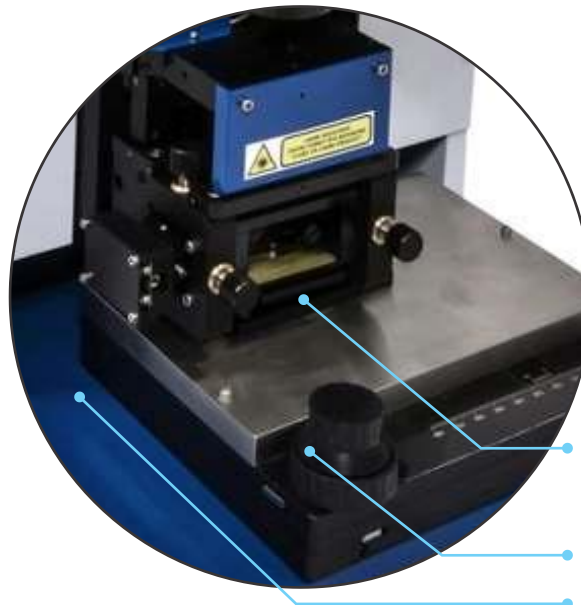

AFM
WORKSHOP™

- Sample holder with six magnets for standard AFM sample disks.
- XY adjustment mechanism.
- Sample platform with tapped holes for adding varying sample holding fixtures.

NP-AFM-4022 STAGE

Wafers and discs up to 8" in diameter are accommodated by the NP-AFM-4022 stage. The vacuum chuck has a unique design that holds the samples firmly while also enabling quick adjustments to accommodate varying diameters of sample sizes.

There is a "two-tiered" translation system to locate features for AFM imaging.

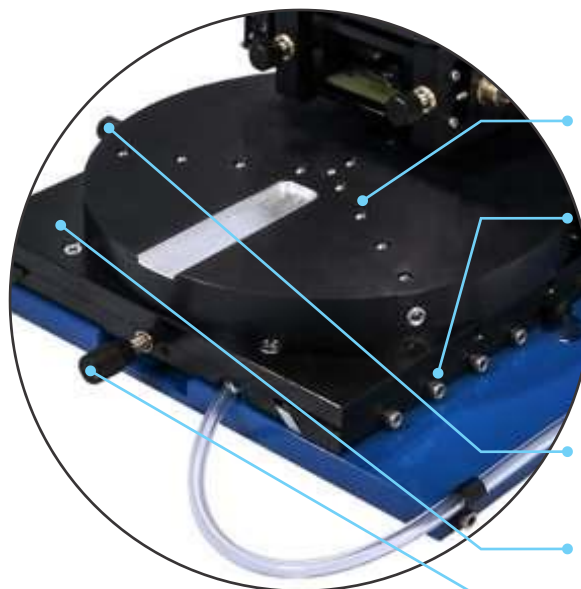

- Vacuum ports at surface of vacuum chuck, configurable for 2, 4, 6, and 8" wafers.
- Stage lock screw.
- Micrometer screws for precision motion of the vacuum chuck.
- 4" linear motion stage.
- Vacuum chuck rotates 360°.

Screws with o-ring seals are provided and allow selection of the correct vacuum chuck diameter.

EBOX

Electronics in the NP-AFM are constructed around industry-standard USB data acquisition electronics. The critical functions, such as XY scanning, are optimized with a 24-bit digital-to-analog converter. With the analog Z feedback loop, the highest fidelity scanning is possible. Vibrating mode scanning is possible with both phase and amplitude feedback using the high sensitivity phase detection electronics.



- ▶ **24-bit scan DAC**
Scanning waveforms for generating precision motion in the XY axis with the piezo scanners are created with 24-bit DACS driven by a 32-bit micro controller. With 24-bit scanning, the highest resolution AFM images may be measured. Feedback control using the XY strain gauges assures accurate tracking of the probe over the surface.
- ▶ **Phase and Amplitude Detector Circuit**
Phase and amplitude in the Ebox are measured with highly stable phase and amplitude chips. The system can be configured to feed back on either phase or amplitude when scanning in vibrating mode.
- ▶ **Signal Accessible**
At the rear of the Ebox is a 50 pin ribbon cable that gives access to all of the primary electronic signals without having to open the Ebox.
- ▶ **Precision Analog Feedback**
Feedback from the light lever force sensor to the Z piezoceramic is made using a precision analog feedback circuit. The position of the probe may be fixed in the vertical direction with a sample-and-hold circuit.
- ▶ **Variable Gain High Voltage Piezo Drivers**
An improved signal to noise ratio, as well as extremely small scan ranges are possible with the variable gain high voltage piezo drivers.



- Microprocessor for scan generation through 24-bit DAC's
- Low noise, variable gain high voltage amplifiers with PID feedback for XY scanning
- Dimensions: Width 6" | Height 10" | Depth 14"
- High fidelity, low noise Z feedback circuits for accurate probe tracking
- Phase and amplitude detection circuits for vibrating mode AFM
- Industry-standard National Instruments USB data acquisition board
- Internally accessible header for signal input/output
- Eight channels of ADC for monitoring and displaying data with LabVIEW™ software

SOFTWARE

Software for acquiring images is designed with the industry-standard LabVIEW™ programming visual interface instrument design environment. Functions such as setting scanning parameters, probe approach, frequency tuning and real time image display are all standard, and included with the product. If special enhancements are needed, LabVIEW™'s programming environment facilitates rapid software development. LabVIEW™ standards ensure that the NP-AFM can be combined with any other instrument using LabVIEW™ VI.



▶ Pre-scan Window

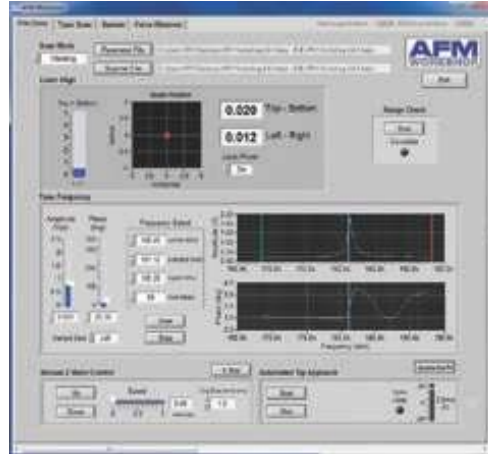

A pre-scan window presents users with a logical sequence to all functions required before initiating a scan.

▶ Scan Window

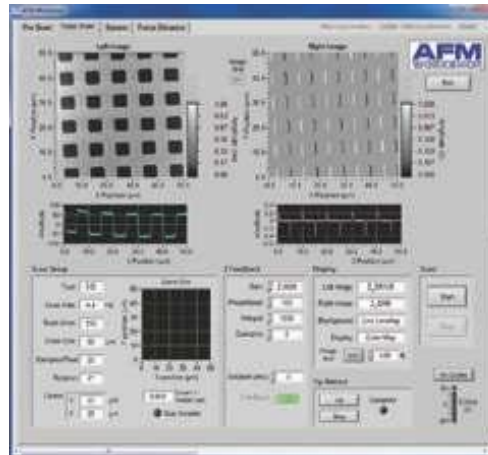

Once the steps in the pre-scan window are completed, the scan window is used for measuring images. Scan parameter, Z feedback parameters, and image view functions may be changed with dialogs on this screen.

▶ LabVIEW™ Window

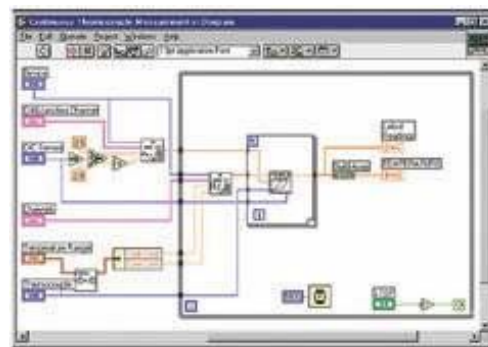

LabVIEW™ is an industry-standard programming environment for controlling instrumentation. All the software for the NP-AFM is written with LabVIEW™ and can be readily customized for specialized applications.

Any instrumentation already using LabVIEW™ can be added to the NP-AFM to create new

IMAGE ANALYSIS SOFTWARE

Included with the NP-AFM is Gwyddion open source SPM image analysis software. This complete image analysis package has all the software functions necessary to process, analyze and display SPM images.



- » Visualization: false color representation with different types of mapping
- » Shaded, logarithmic, gradient- and edge-detected, local contrast representation, Canny lines
- » OpenGL 3D data display: false color or material representation
- » Easily editable color maps and OpenGL materials
- » Basic operations: rotation, flipping, inversion, data arithmetic, crop, resampling
- » Leveling: plane leveling, profiles leveling, three-point leveling, facet leveling, polynomial background removal, leveling along userdefined lines
- » Value reading, distance and angle measurement
- » Profiles: profile extraction, measuring distances in profile graph, profile export
- » Filtering: mean, median, conservative denoise, Kuwahara, minimum, maximum, checker pattern removal
- » General convolution filter with user-defined kernel
- » Statistical functions: Ra, RMS, projected and surface area, inclination, histograms, 1D and 2D correlation functions, PSDF, 1D and 2D angular distributions, Minkowski functionals, facet orientation analysis
- » Statistical quantities calculated from area under arbitrary mask
- » Row/column statistical quantities plots
- » ISO roughness parameter evaluation
- » Grains: threshold marking and un-marking, watershed marking
- » Grain statistics: overall and distributions of size, height, area, volume, boundary length, bounding dimensions
- » Integral transforms: 2D FFT, 2D continuous wavelet transform (CWT), 2D discrete wavelet transform (DWT), wavelet anisotropy detection
- » Fractal dimension analysis
- » Data correction: spot remove, outlier marking, scar marking, several line correction methods (median, modus)
- » Removal of data under arbitrary mask using Laplace or fractal interpolation
- » Automatic XY plane rotation correction
- » Arbitrary polynomial deformation on XY plane
- » 1D and 2D FFT filtering
- » Fast scan axis drift correction
- » Mask editing: adding, removing or intersecting with rectangles and ellipses, inversion, extraction, expansion, shrinking
- » Simple graph function fitting, critical dimension determination
- » Force-distance curve fitting
- » Axes scale calibration
- » Merging and immersion of images
- » Tip modeling, blind estimation, dilation and erosion

VIDEO MICROSCOPE

A video optical microscope in an AFM serves three functions: aligning the laser onto the cantilever in the light lever of the AFM, locating surface features for scanning, and facilitating probe approach. The NP-AFM includes a high performance video optical microscope along with a 3 megapixel camera, light source, microscope stand, and Windows software for displaying images.

AFM
WORKSHOP™

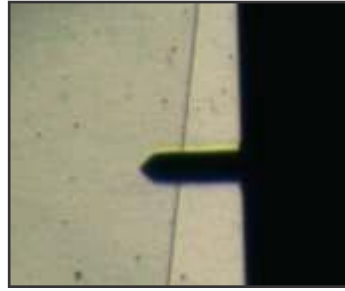

Video microscope used to locate surface features for scanning. The vibrating mode cantilever is 125 μ long.



Laser alignment is greatly facilitated with the video optical microscope. This non-vibrating cantilever is 450 μ long. The red spot is from the laser reflecting off the cantilever.

PROBE HOLDER EXCHANGE

The NP-AFM utilizes a unique probe holder/exchange mechanism. Probes are held in place with a spring device that mates with a probe exchange tool.

This combination makes changing probes fast and easy on the NP-AFM.

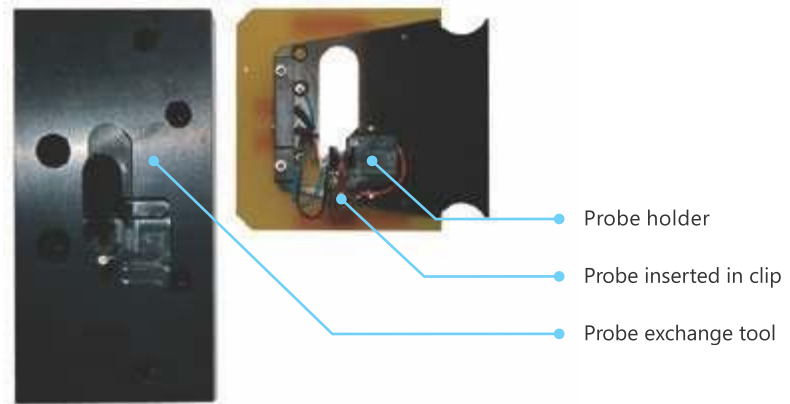

SCANNING MODES

Standard with every NP-AFM are nonvibrating (NV) mode and vibrating (V) modes for creating topography scans.

Additional modes included with the product are lateral force imaging and phase mode imaging.

Any scanning mode that can be implemented with a light lever AFM is possible with the NP-AFM.

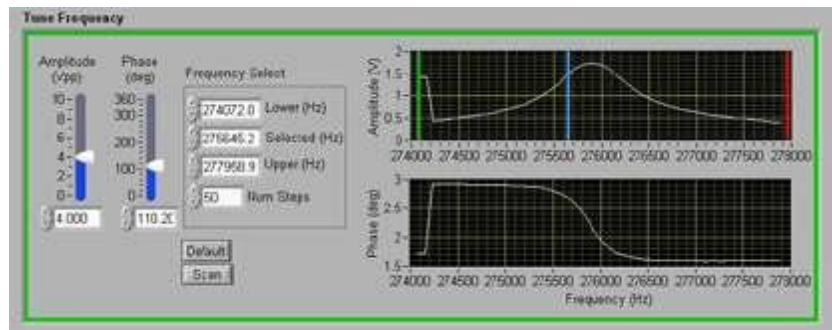

With the window above the resonance frequency of a cantilever is readily measured. Additionally, the phase characteristics of the probe-sample interaction may be captured.

SPECIFICATIONS

▶ 40 Micron xyz Scanner

- » Type Modified Tripod
- » xy Linearity < 1%
- » xy Range > 40 μ
- » xy Resolution < 3 nm closed loop
< 0.3 nm open loop
- » xy Actuator type Piezo
- » xy Sensor type Strain Gauge
- » z Range > 7 μ
- » z Linearity < 5 %
- » z feedback noise < 0.15 nm
- » z Actuator Type Piezo
- » z Sensor type None

▶ Light Lever AFM Force Sensor

- » Probe Types Industry-standard
- » Probe Insertion Manual
- » Probe Exchange Tool
- » Probe Holding Mechanism Clip
Vibrating Mode Piezo
Electrical Connector to Probe
- » Laser/Detector Adjustment Range +/- 1.5 mm
- » Adjustment Resolution 1 μ
- » Minimum Probe to Objective 25 mm
- » Laser Type 670 nm Diode, < 3 mW
- » Laser Focus < 25 μ
- » Detector
 - Type 4 Quadrant
 - Band Width > 500 kHz
 - Signals Transmitted TL, BL, TR, BR
 - Gain Low, High Settings
- » Probe sample angle 10°

▶ Digital Data Input Output

- » Connection USB
- » Scanning DAC
 - Number 2
 - Bits 24
 - Frequency 7 kHz
- » Control DAC
 - Number 2
 - Bits 14
 - Frequency 2 kHz
- » ADC
 - Number 8
 - Bits 14
 - Frequency 48 kHz

▶ Z Motion

- » Type Direct Drive
- » Range 25 mm
- » Drive Type Stepper Motor
- » Min. Step Size 330 nm
- » Slew Rate 8 mm/minute
- » Limit Switch Top, Bottom
- » Control Software – Rate, Step Size

▶ Analog Electronics

- » Vibrating Mode
 - Freq Range 2 kHz – 800 kHz
 - Output Voltage 10 Vpp
 - Demod. Freq TBD
- » Z Feedback
 - Type PID
 - Bandwidth > 3 kHz
 - Sample Hold Yes
 - Voltage 0 – 150 V
- » xy Scan
 - Voltage 0 – 150 V
 - Bandwidth > 200 Hz
 - Pan & Zoom 22 Bits
- » Tip Approach Cutoff < 20 μ sec.

▶ Software

- » Environment LabVIEW™
- » Operating System Windows
- » Image Acquisition Real Time Display (2 of 8 channels)
- » Control Parameters
 - PID Yes
 - Setpoint Yes
 - Range Yes
 - Scan Rate Yes
 - Image Rotate 0 and 90°
- » Laser Align Yes
- » Vibrating Freq. Display Yes
- » Force Distance Yes
- » Tip Approach Yes
- » Oscilloscope Yes
- » Image Store Format Industry-standard
- » Image Pixels 16 x 16 to 1024 x 1024
- » H.V. Gain Control XY and Z
- » Real Time Display Line Level, Light Shaded, Grey Color Palette
- » Calibration System Window
- » Probe Center Yes

SPECIFICATIONS CONTINUED...

▶ Video Microscope

	Minimum Zoom	Maximum Zoom
Field of view	2 X 2 mm	300 X 300 μ
Resolution	20 μ	2 μ
Working Distance	114 mm	114 mm
Magnification	45 X	400X

▶ Computer

- » Industry-standard Computer & Monitor (laptop available upon request)
- » Windows
- » AFMWorkshop LabVIEW.exe installed
- » Video Microscope software installed

▶ NP-AFM-4012

- » Overall XY Range 2" x 3" (5 mm x 7.6 mm)
- » Resolution 3 μ
- » Max. Sample Size 6" x 6" x 1/2" (150 mm x 150 mm x 12 mm)

▶ NP-AFM-4022

- » 8" (200 mm) Diameter Vacuum Chuck
- » Linear Range 4" (100 mm)
- » Rotational Range 360°
- » Secondary Manual XY – 1/4" (6 mm)
- » Vacuum Required

▶ NP-AFM-4032 Motorized XY Stage (Special Order)

- » Travel Range (X & Y) 100 x 100 mm
- » Travel Guide Crossed Roller Bearing
- » Material Finish Anodized Aluminum
- » Max Load Capacity 50 Kg
- » Design Resolution 20 μ , 1 μ (micro-steps)
- » Max Velocity 40 mm/sec
- » Bi-directional Repeatability 3 μ
- » Absolute On-Axis Accuracy 5 μ
- » Straightness 5 μ
- » Degree of Parallelization 15 μ
- » Pitching 50"
- » Yawing 25"
- » Backlash 2 μ

▶ Sample Holder

- » Type Vacuum Chuck
- » Max. Lateral Dimensions 200 mm
- » Max. Height 25 mm
- » Rotational Range 360°

Z Noise performance depends greatly on the environment the NP-AFM is used in. Best Z noise performance is obtained in a vibration free environment.

Every effort is made to present accurate specifications, however, due to circumstances out of the AFMWorkshop's control specifications are subject to change.